



**Color Touch Screen Digital  
Rockwell Hardness Tester  
DigiRock DR3  
Operation Manual**

**Sinowon Innovation Metrology Manufacture Limited**  
**[www.sinowon.com](http://www.sinowon.com)**

## *Precautions*

1. Carefully read the Operation Manual before you use the hardness tester and get to know thoroughly the operation procedure and the usage precautions so as to avoid the damages to the hardness tester and the safety accidents caused by the improper operation.
2. All the bands and the anti-shock tapes should be carefully removed before the hardness tester is installed and calibrated.
3. The single-phase 3-pin socket should be used for the power source of the hardness tester and the ground connecting cable should meet the safety requirements.
4. It is strictly prohibited to tamper with the installed position of all the electric component parts, switches, and sockets of the hardness tester without permission, otherwise it will cause accident.
5. It should not to turn the force knob or the Rotating Wheel during the loading and unloading operations and the dwell time of the test force.
6. Our company tries to improve the quality of the hardness testers and renew their structure. In case the contents in the Operation MANUAL are a bit different with the actual structure of the instrument, it is hoped and apologized for the fact that the further notice will not be given.

## Contents

<b>1 Brief Introduction</b> .....	<b>1</b>
<b>2 Technical Data</b> .....	<b>2</b>
2.1 Technical Data.....	2
2.2 Working Principle.....	3
<b>3 Installation Steps</b> .....	<b>5</b>
3.1 Working Conditions.....	5
3.2 Unpacking and Positioning.....	5
3.3 Components Illustration.....	5
3.4 Weights Installation.....	6
3.5 Weights and Force Table.....	6
<b>4 Operation</b> .....	<b>7</b>
4.1 Power On.....	7
4.2 Touch Screen Operation.....	7
4.3 Key Panel Operation.....	8
<b>5 Operation Example</b> .....	<b>9</b>
5.1 System Setup.....	9
5.2 Preparation.....	13
5.3 Operation Steps.....	14
5.4 Viewing Data.....	16
5.5 Correction.....	17
5.6 Default Setup.....	18
<b>6 Maintenance of Hardness Tester</b> .....	<b>19</b>
6.1 Operation Attention.....	19
6.2 Daily Maintenance.....	19
6.3 Trouble Shooting.....	20
<b>7 After Sales Service</b> .....	<b>21</b>
<b>8 Storage/Transportation Attention</b> .....	<b>22</b>
<b>Table 1 ( Hardness Value Corrections With Testing On Convex Cylindrical Surfaces )</b> .....	<b>23</b>
<b>Table 2 ( Allowable Repeatability and Error Table )</b> .....	<b>24</b>

## 1 Brief Introduction

- Hardness is one of the important mechanic characteristics of metal materials, while the hardness testing is an important method to judge the quality of the metal material or its component parts. The hardness of the metal is correspondent to its other mechanic characteristics, so its mechanic characteristics such as the strength, tiredness, wriggling and wearing out can be tested out approximately through its hardness testing.
- The Touch Screen Digital Rockwell Hardness Tester is equipped with a newly-designed large display screen with good reliability, excellent operation and intuitive reading, thus it is a high-tech product combining the mechanic and electric features. Its main function is as follows:
  - 1) Available to test all Rockwell scales.
  - 2) Plastic Rockwell scales (optional).
  - 3) Hardness conversion among different hardness scales.
  - 4) Test data reviewing and analysis.
  - 5) Optional wireless printer to print test data.

## 2 Technical Data

### 2.1 Technical Data

<b>Product Name</b>	<b>Color Touch Screen Digital Rockwell Hardness Tester</b>
Model	DigiRockDR3
Code#	811-130
Rockwell Scales	HRA、HRB、HRC、HRD、HRE、HRF、HRG、HRH、HRK、HRL、HRM、HRP、HRR、HRS、HRV
Preliminary Test Force	10Kgf(98.07N) Permitted Error : $\pm 2.0\%$
Test Force	60Kgf(588.4N)、100Kgf(980.7N)、150Kgf(1471N) Permitted Error : $\pm 1.0\%$
Dwell Time	Adjustable 1-60s
Hardness Indication	5.2" Touch Screen, Resolution:640x480
Resolution	0.1HR
Loading Control	Auto Loading/Dwell/Unloading
Hardness Conversion	HRC、HV、HBS、HBW、HK、HRA、HRD、HR15N、HR30N、HR45N、HS、HRF、HR15T、HR30T、HR45T、HRB
Conversion Standards	ASTM、DIN
Language Option	Chinese, English, German, Portuguese, Turkish, Czech, Korean
Correction Range	-3.0HR to +3.0HR, Step 0.1HR
Data Memory	2000 Single Measuring Result, Curve Analysis, Results Reviewing And Analysis
Data Output	Optional Blue Tooth Mini Printer
Max. Height Of Specimen	175mm
Instrument Throat	165mm
Power supply	AC220V/50Hz;AC110V/60Hz
Dimension(LxWxH)	546x182x755mm
Packing Dimension	620x460x870mm
Gross/Net Weight	120Kg/90Kg
Execution Standard	GB/T230.2, JIS Z2245, EN-ISO6508, ASTM E-18

## 2.2 Working Principle

The Rockwell hardness test method consists of indenting the test material with a diamond cone or hardened steel ball indenter. The indenter is forced into the test material under a preliminary minor load  $F_0$  (Fig. 1A) usually 10 kgf. When equilibrium has been reached, an indicating device, which follows the movements of the indenter and so responds to changes in depth of penetration of the indenter is set to a datum position. While the preliminary minor load is still applied an additional major load is applied with resulting increase in penetration (Fig. 1B). When equilibrium has again been reached, the additional major load is removed but the preliminary minor load is still maintained. Removal of the additional major load allows a partial recovery, so reducing the depth of penetration (Fig. 1C). The permanent increase in depth of penetration, resulting from the application and removal of the additional major load is used to calculate the Rockwell hardness number.

$$HR = E - e$$

$F_0$  = preliminary minor load in kgf

$F_1$  = additional major load in kgf  $F$  = total load in kgf

$e$  = permanent increase in depth of penetration due to major load  $F_1$  measured in units of 0.002 mm

$E$  = a constant depending on form of indenter: 100 units for diamond indenter, 130 units for steel ball indenter

HR = Rockwell hardness number  $D$  = diameter of steel ball

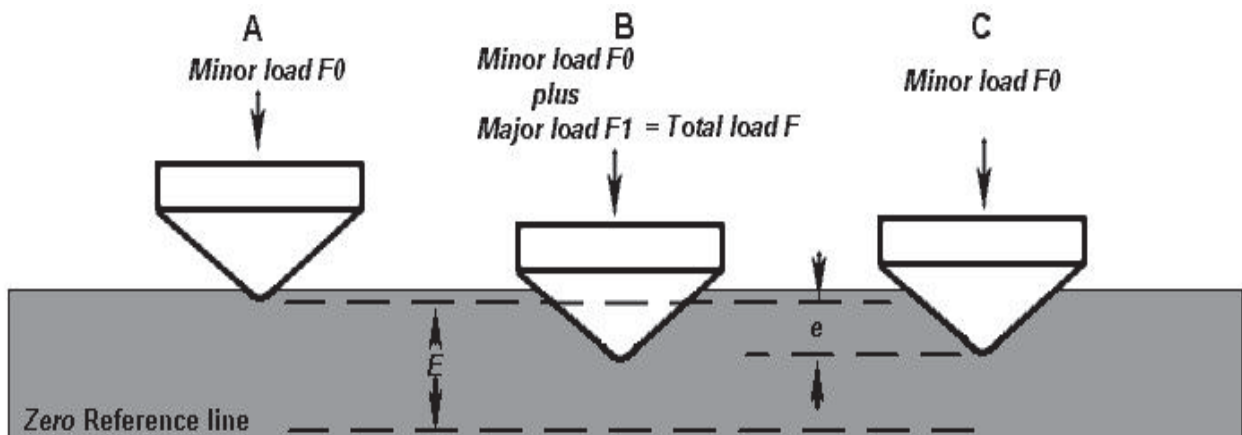

**1) Rockwell Scale, Indenter, Test Force and Applicable Range of the Rockwell Hardness Testing**

Hardness Scale	Hardness Symbol	Indenter	Initial Test Force F0 ( N )	Main Test Force F1 ( N )	Total Test Force F0+ F1 ( N )	Application Range
A	HRA	120°Diamond Indenter	98.07	490.3	588.4	20 ~ 88HRA
B	HRB	1.5875mm Ball Indenter	98.07	882.6	980.7	20 ~ 100HRB
C	HRC	120°Diamond Indenter	98.07	1373	1471	20 ~ 70HRC
D	HRD	120°Diamond Indenter	98.07	882.6	980.7	40 ~ 77HRD
E	HRE	3.175mm Ball Indenter	98.07	882.6	980.7	70 ~ 100HRE
F	HRF	1.5875mm Ball Indenter	98.07	490.3	588.4	60 ~ 100HRF
G	HRG	1.5875mm Ball Indenter	98.07	1373	1471	30 ~ 94HRG
H	HRH	3.175mm Ball Indenter	98.07	490.3	588.4	80 ~ 100HRH
K	HRK	3.175mm Ball Indenter	98.07	1373	1471	40 ~ 100HRK

## 3 Installation Steps

### 3.1 Working Conditions

3.1.1 Under the room temperature between 10~30°C.

3.1.2 The relative humidity in the test room  $\leq 65\%$ .

3.1.3 Without vibration, corrosive medium and serious dust in the surrounding environment.

### 3.2 Unpacking and Positioning

3.2.1 Cut the belts on the packing box, screw off the screws on the bottom plate of the box and remove off the upper body of packing box. Take out the accessories kit.

3.2.2 Unscrew the two (2) M10 outer hexagonal bolts under the bottom plate with a spanner, to separate the hardness tester from the bottom plate (take care of the safety).

3.2.3 After unpacking, the tester shall be placed on a stable and solid working table with horizontal deviation less than 1mm/m ( There is a level in the accessories kit ). A hole shall be drilled at a proper location on the working table (see Fig.1) to enable the Up and Down Lead Screw to operate properly. We suggest that the height of working table should be about 500mm.

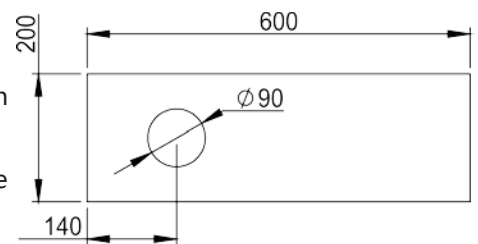

Fig 3-1

3.2.4 After the hardness tester is properly placed (Fig.2), open the Upper Cover (8) and the Back Cover (9). Untie the fastening rubber tape (Fig.12) on the Connecting Rod (21) and draw out the foam block under Protecting Gasket (24) and Lever (13). Untie all the white gauzes on moving parts and then recover the tester to keep away dust.



1. Take care during unpacking and installation, avoid damage of tester parts.
2. After installation, please check no extra objects should be left inside.
3. Have a good knowledge of components structure and avoid wrong operation.

### 3.3 Components Illustration

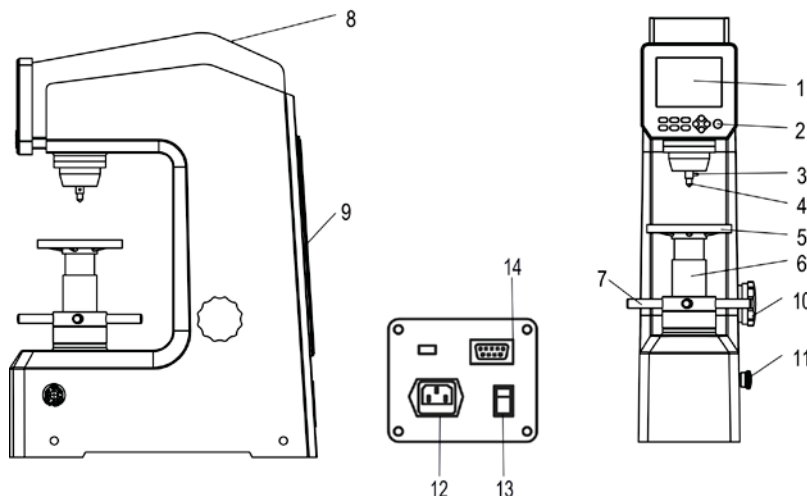

Fig 3-2



- |                  |                              |                                |                   |
|------------------|------------------------------|--------------------------------|-------------------|
| 1、 Touch Screen  | 2、 Control Panel             | 3、 Fastening Screw of Indenter | 4、 Indenter       |
| 5、 Test Anvil    | 6、 Upper and Down Lead Screw |                                | 7、 Rotating Wheel |
| 8、 Upper Cover   | 9、 Back Cover                | 10、 Force Knob                 | 11、 Power Switch  |
| 12、 Power Socket | 13、 Power Switch             | 14、 VGA Interface              |                   |

### 3.4 Weights Installation

3.4.1 During installation of weights, the instrument should be in the state unloading.

3.4.2 Take the weight group out of the accessories kit and clean them thoroughly. Rotate the Load-Change Hand Wheel (10) to the place number 588, and then take the Hanging Rod (16) from the Back Cover and insert it in the hole of the Weight A (20), fasten the M10 Nut (21) at the tail of the Hanging Rod. Hook the Hanging Rod in the ear of the tail of the Lever (15). And then place the weight B (19) and Weight C (18) separately on two Fork-Shaped Frames (17). At this point, rotate the Load-Change Hand Wheel clockwise for a whole cycle and observe the round pegs on both sides of the Weight and see if they are properly placed in the groove of the Fork-Shaped Frame. The Weights should not touch the inside wall of the instrument body (See Fig 3-2, 3-3).

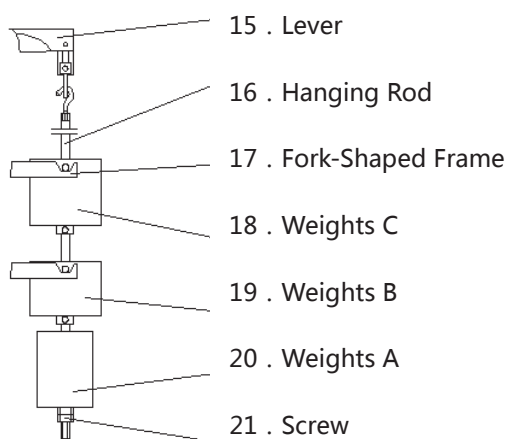

Fig 3-3

### 3.5 Weights and Force Table

Table 3

Scale	Test Force ( N )	Graduated Value on Load-Change Hand Wheel	Force on the Weight(Weight Code)
HRA	588.4(60kg)	588.4(60)	Handing Rod +Weight A
HRB	980.7(100kg)	980.7(100)	Handing Rod+ Weight A+ Weight B
HRC	1471(150kg)	1471(150)	Handing Rod +Weight A +Weight B +Weight C

## 4 Operation

### 4.1 Power On

4.1.1 Connect the power source, turn on the boat-shaped Switch (11), the main Screen appears the operation page (Fig.4-1).



Fig 4-1 Power On Interface

### 4.2 Touch Screen Operation

- **Single/Group:** Standard test mode (Single) and group test mode (batch mode) switch. When show single, enter standard test mode, test number show NG; click single, it will show average, enter batch mode, test number show 00. See below pictures. ( Fig 4-2 )

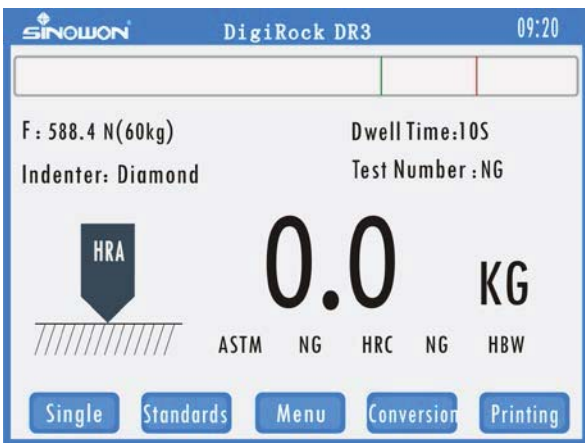

Fig 4-2 Standard test Mode (Single)

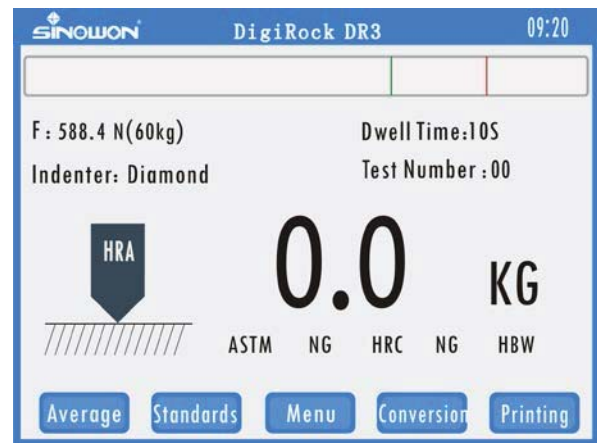

Fig 4-3 Group test Mode

- **Standard** : hardness conversion according to different standards
- **Menu** : enter system setup interface
- **Conversion** : select hardness conversion scales

Shown as Fig 4-2, HRC, HBW below the test result represent the conversion value under the

scale HV. When put scale button, the two scale change and show the relevant conversion value at the same time.

- **Printing** : Print test data ( effective before unloading)

### 4.3 Key Panel Operation



Fig 4-4 Control Panel



— Press enter system setup



— Zero Clearance for hardness value



— Back to main interface



— Select hardness conversion scales

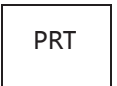

— Printing : Print test data



— Display test results



— Enter to confirm modifications



— Direction button



— Direction button

## 5 Operation Example

### 5.1 System Setup

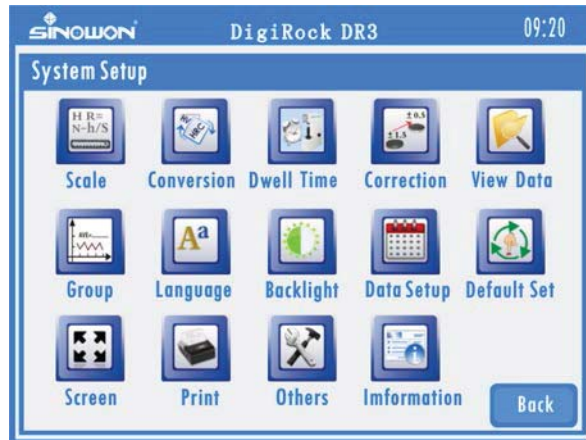

Fig 5-1 System Setup

- Select hardness scale, and confirm test force and indenter type (Fig 5-2)
  - **Conversion Scale Setting :**
- 1) **【Conversion Scale】** : Click the box on right of scale, can select 2 scales at a time: HRC、HV、HBS、HBW、HK、HRA、HRD、HR15N、HR30N、HR45N、HS、HRF、HR15T、HR30T、HR45T、HRB, see Fig5-3..
  - ◆ **Remark :**
    - a) If the converted hardness value is invalid, it will show NG.
    - b) When change hardness conversion value, it can also change saved scale and show corresponding value.
    - c) Click one more time for selected scale, means cancel the selection.
  - 2) **【Conversion Standard】** : Under conversion scales, there are 2 options ASTM and DIN. see Fig5-3.



Fig 5-2 Hardness Scale



Fig 5-3 Hardness Conversion and Standard

- **Dwell Time Setup** : adjust from 1-60s (Fig 5-4). Default time is 5s, for soft material, properly longer dwell time is good, then the indenter could have enough time to touch the specimen surface.
- **Language** : Click Language to select operation language (Fig 5-5).



Fig 5-4 Dwell Time Setup



Fig 5-5 Language

- **Date Setup** : Click to modify year, month and date, click ENTER to update system time. (Fig 5-6).
- **Backlight Setup** : Click backlight to enter interface, drag dot to update backlight (Fig 5-7).



Fig 5-6 Time and Date Setup



Fig 5-7 Backlight Setup

- **Screen Calibration** : Calibrate screen according to display , Enter calibration screen, click the small black cross one by one. (Fig 5-8).
- **Print Setup** : Available for wireless print by connecting bluetooth print device ( optional ), or connect the upper bluetooth module ( optional ) with a computer. Connection steps are as follows:
  - 1) When connect with a bluetooth print device: turn on the print device, wait for its stand-by state; When connect with a computer: insert the upper bluetooth module ( optional ) into the computer USB.
  - 2) Click the small box in front of the [ connect the printer], start signal search function shown as Fig 5-9.
  - 3) It will finish signal search after seconds, at this time click Connect as representation, when it shows Connect OK, we have connected bluetooth device successfully with PC. Detailed introduction about PC setup, please see [ wireless data transmission setup ].
  - 4) Click back to the [ viewing data ] to execute data printing operation. ( connect with PC, data transmit to PC ). Detailed introduction, please see [ about data printing ].



1. Make sure blue tooth is power on before connect with hardness tester.
2. Blue tooth sensor range is 1–3 meter.
3. Connect one time is OK.
4. If hardness tester is powered off, then reconnect Blue tooth once restart hardness tester.
5. If connect failure, then reconnect again.

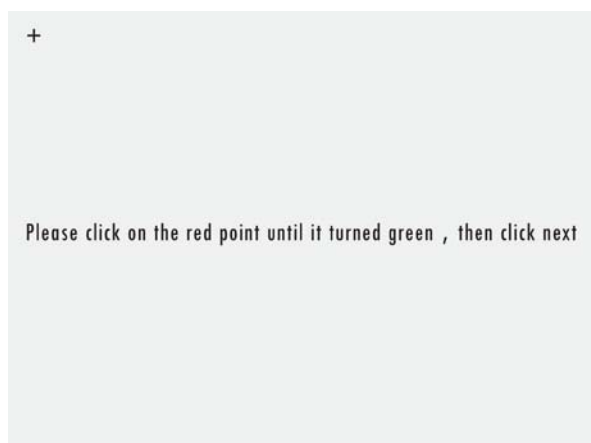

Fig 5-8 Screen Calibration

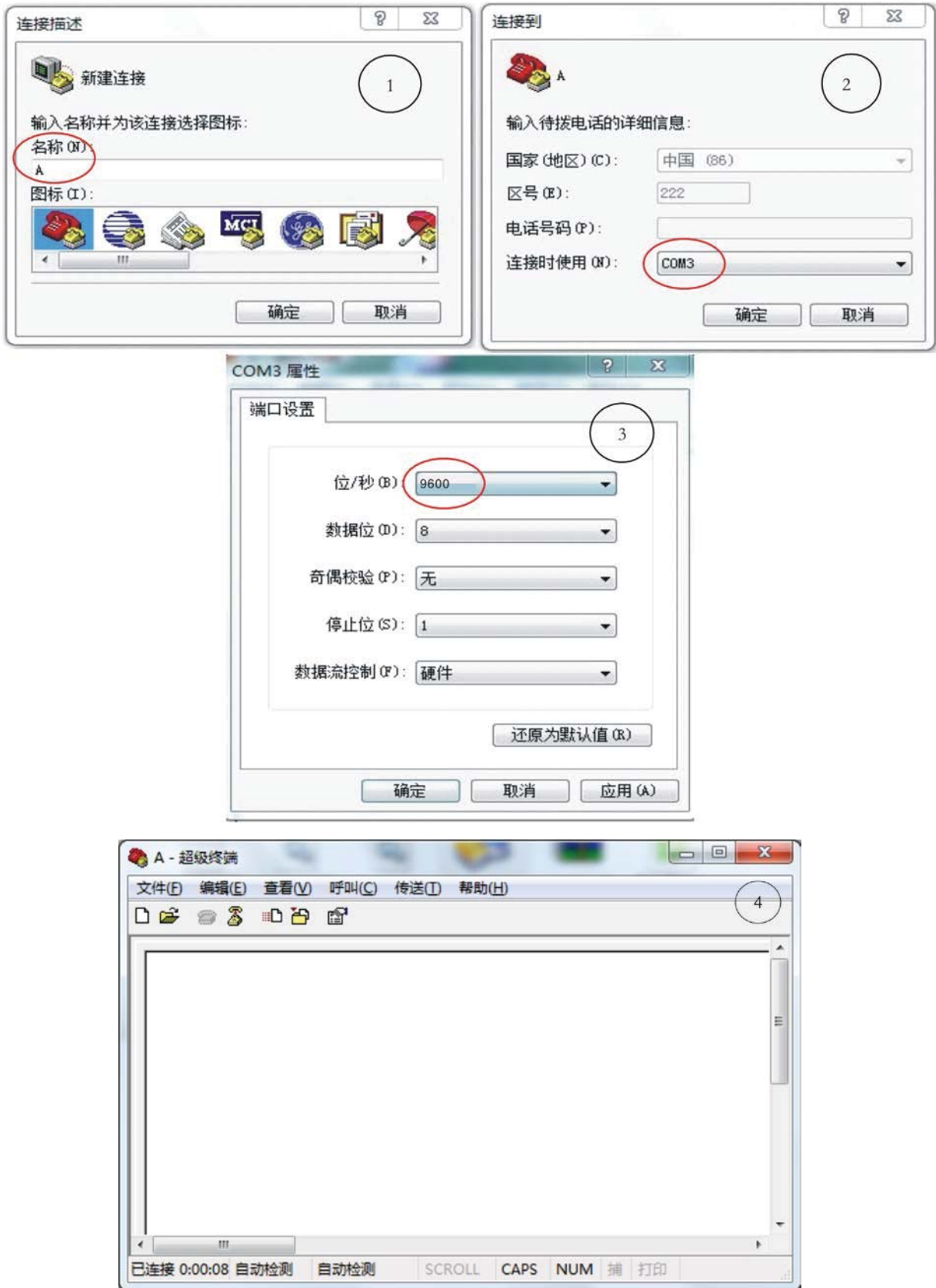

Fig 5-9 Searching for Devices

● **Wireless data transmission setup :**

Connect successfully with PC, setup as follows:

- 1) **XP System:** click start-program-accessory-communication-hyperterminal one by one, it will pop out a new connection window ( Figure ①) -edit connection name-click OK.
- 2) **Above Win7 System:** for those systems have not hyperterminal, extra installation is needed. Users can download from the internet. Double-click the function icon after extraction, it will show a new connection window ( Figure ①) -edit connection name-click OK.
- ◆ It will pop out region setup when it is firstly used, users should set up as needed.
- 3) Choose the using com port ( as the following Fig, port is COM3) baudrate [B/S] set up as 9600 ( Fig②,③), others do not change, click OK after every setup.
- 4) All the above finished, executive print operation, data will transmit to PC. ( Fig④)



- **Others Setup :** Click other setup, the submenu catalogue shown as 5-10. √ shows up, it is on state; √ does not show up, it is off state.

1) **【Click Sound】** , Switch on system sound, if not there is no sound except test process.

- 2) **【Click enable default name】** Then will display name edit dialog box, then input name and click Enter to confirm. Name consist set name and number, see Fig 5-11, the saved name is Name01. If not click, default name is 16 digits 0 and increases.
  - a) When use set name of data, it shows like name + digits, like Name01, the coming is Name02, etc.
  - b) When use default name, it shows "0000000000000001" .
  - 3) **【The maximum number of tests】** This is only for average mode.
- ◆ **Remark:** this function is only available for group test mode, at most 10 test results, it will enter into next group when finished. Analyzed in test result line chart [ data group ].



Fig 5-10 Others Settings



Fig 5-11 Edit Default Name

## 5.2 Preparation

5.1.1 The surface of the specimen should be smooth and clean without any feculence, oxidized peels, concaves and the outstanding machining signs. The supporting plane of specimen and the testing table should be clean to assure a good smoothness between them.

5.2.2 The Min. thickness of the specimen should be 10 times superior to the depth of the indentation. After the test, the back of the specimen should not have any visible signs of deformation (Fig.5-12).

5.2.3 The specimen should be stably fixed on the testing anvil. There should be no any movement of the specimen during the loading of test force and the test force should be loaded perpendicularly on the specimen.

5.2.4 The testing table should be chosen according to the shape and size of the specimen. If the specimen has an irregular shape, a special holder should be made in accordance with the particular geometrical shape, so as to measure out correct hardness displaying values.

5.2.5 When the specimen is columned in shape, the V-shaped testing table must be used. The results of the test should be revised. The revised values are all positive numbers. The revised values of the Rockwell Hardness Scales for the convex columned specimen are as Table 1.



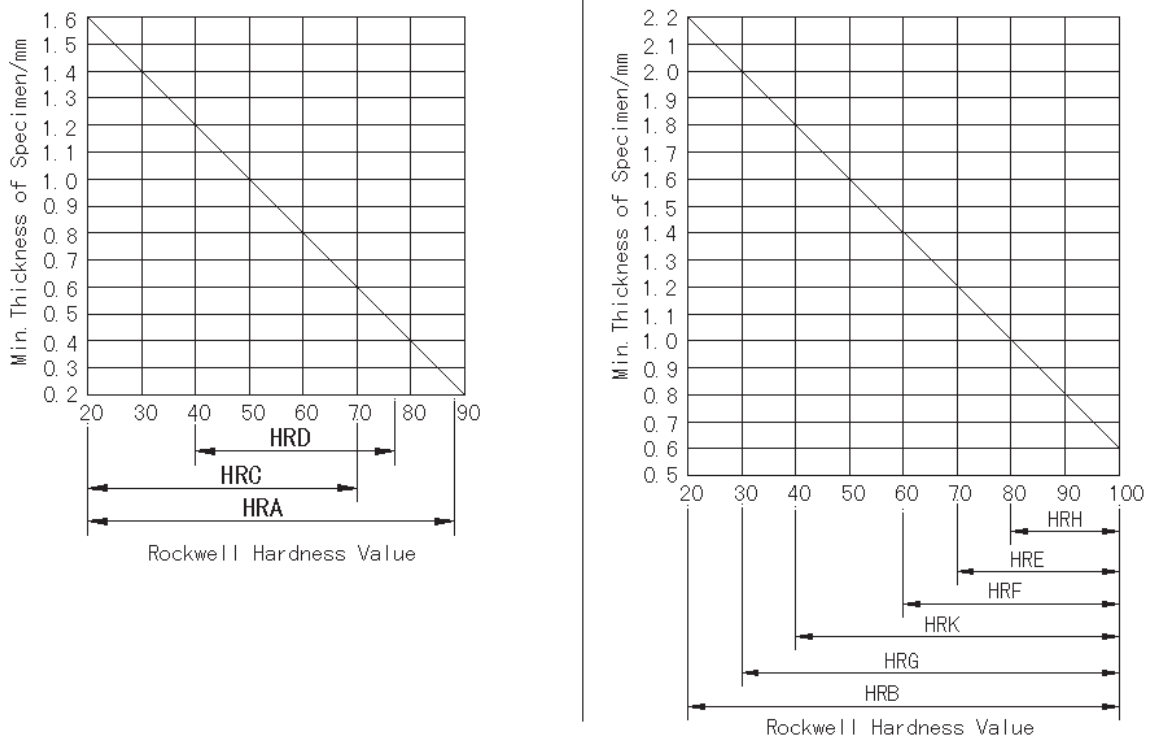

Fig 5-12 Min. thickness of specimen

## 5.3 Operation Steps

5.3.1 Test HRC standard hardness block, and select the test force 1471N (150kg) and the diamond indenter according to Table 1. Rotate the Load-Change Hand Wheel clockwise to determine the total test force.

5.3.2 Push the Indenter (4) into the hole of main spindle closely against the supporting plane and make the caved plane of the indenter handle face the screw. Fasten slightly the Fastening Screw of Indenter (3), and then place the hardness block on the Testing Table (5), see Fig 3-2.

5.3.3 Press MENU enter System Setup, see Fig 5-1

- 1) Select scale, then press ENT display dialog box, select HRC, and standard ASTM, see Fig 5-2.
- 2) Select hardness conversion scale, see Fig 5-3.
- 3) Setup dwell time, see Fig 5-4.
- 4) Press ESC back to main interface.

5.3.4 Turn the Rotating Wheel (7) clockwise to lift up the Up and Down Lead Screw. The specimen slowly touches the indenter without any shock until the hardness tester displays 10kgf on screen; at this time, the buzzer gives a sound, it has been loaded the initial test force. The Testing Table stops rising. (When the Testing Table moves up too fast and the screen display a value over 10kgf, the buzzer produces a long sound, showing the operation is not correct. At this point, the Testing Table should be lowered down and the testing position should be changed for another test.)

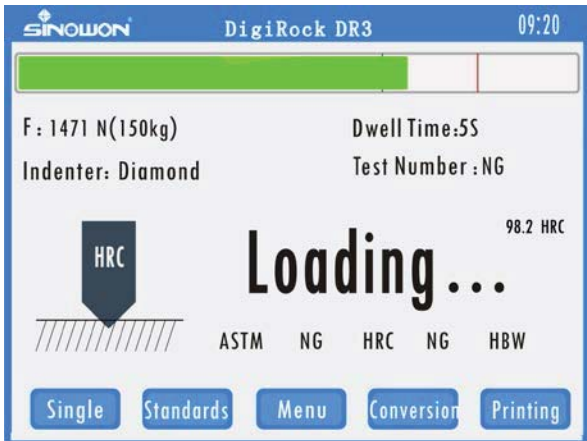

Fig 5-13 Loading

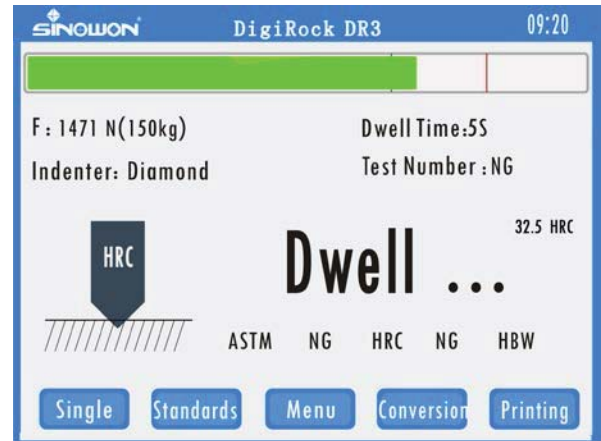

Fig 5-14 Dwell

5.3.5 The motor should be started, making the automatic loading of main test force. The dwell time of the total test force is 5 seconds and the screen will back-counting of the dwell time to 0 second (see Fig 5-15).The motor should be turned again; the instrument automatically unloads the main test force; then keeps the initial test force. When the buzzer sounds, read out the hardness value showed in the Hardness Value Displaying Area on the screen, see Fig 5-16.

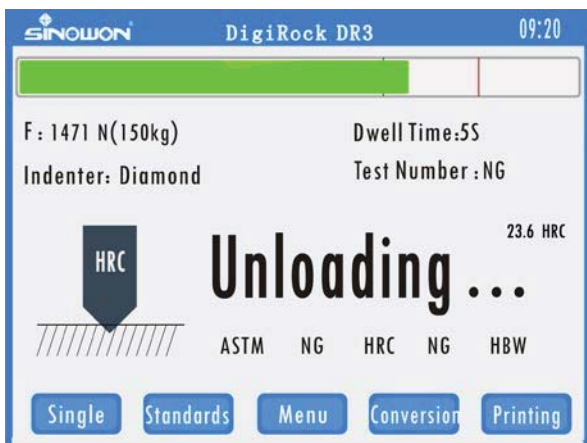

Fig 5-15 Unloading

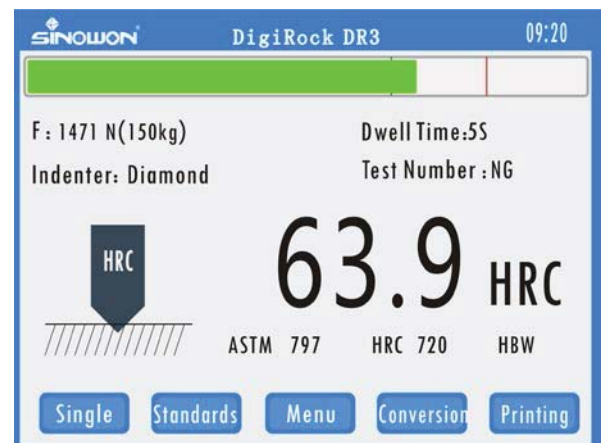

Fig 5-16 Hardness Result

5.3.6 Turn the Rotating Wheel anti-clockwise and lower down the Testing Table. And then change the testing points to be tested, repeat the operation described above, see Fig3-2.

5.3.7 The number of the point to be tested is not less than 5 (the first point in not include.) The number of the points to be tested may be reduced a bit for the specimen tested in a serial.



**Remark:** Above operation also can be done by touch screen. During the loading and unloading of the test force, it is prohibited to rotate the Load-Change Hand Wheel. The forced rotation would damage the components inside the instrument, and cause the disorder to the test force.

## 5.4 Viewing Data

### 5.4.1 Single test data review

- 1) **List** : Each page shows 5 test results, the latest one is on top, see Fig5-17.
- 2) **Details** : To show the detail information of each test result, like test time, test scale, hardness conversion. Fig5-18.
- 3) **Graph**: under the result list to select more pieces data ( $\leq 10$ ), then click graph, system will show the curve to see the tendency and amplitude of variation, we can obviously see the differences between each data. The Max and Min value will be showed in red. See below picture Fig5-19, result on curve is the hardness value.
- a) AVE : Average value.
- b) S : Standard deviation ; if shows "Err" , means exceeds permitted error.
- c) %S : Percentage of deviation ; if shows "Err" , means exceeds permitted error.
- d) %RE : Repeatability. The value is small, means hardness is stable.
- 4) **About Print** :
  - a) Print Single Result : Click Print ( or press [PRT] on panel ) on the page of list or details can print single result.
  - b) Group Print : Click  ( or press [PRT] on panel ) on graph page.



Fig 5-17 Data List



Fig 5-18 Particulars

### 5.4.2 Group Data Review

Click on the "Group Data" to enter the interface as shown in Figure 5-20 (this page is the average measurement result analysis). "Chart" appears directly. Click the up and down arrow keys to select a test group, Click  to modify the test group name in the interface. As for interface description and print, please follow 3) and 4) mentioned above.

### 5.4.3 Quick Review

The main interface panel enter "DISP" key to quick access data viewing interface, this applies to a single point and average test data review.

◆ **Remark:** Under group mode, if test times no reach to Max Tests, cannot view data.

5.4.4 If there is no stored data, when performing the above operations, the system will automatically eject the "NO

DATA" warning dialog box and automatically return to the upper-layer interface.

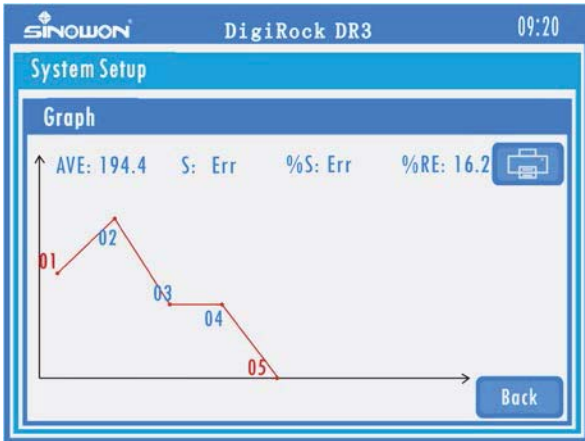

Fig 5-19 Single Test Review

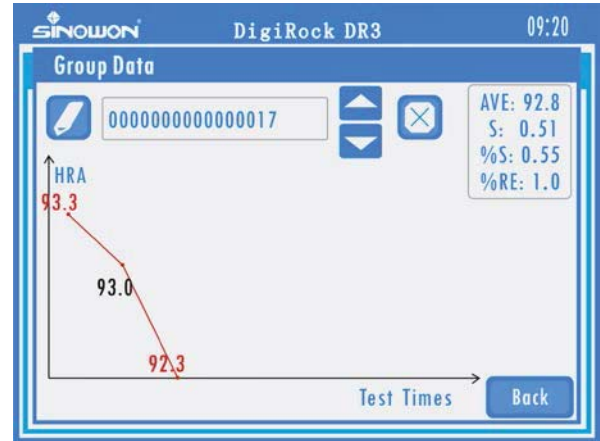

Fig 5-20 Group Data Review

## 5.5 Correction

The accuracy of the displaying hardness value was calibrated before leaving factory. If a tolerance is caused due to the transportation, the operator may regulate it based on the understanding of the instrument structure and principle. The method is as follows:

**Method1** : Remove the Upper Cover

If the displaying value is inferior to the hardness value of standard hardness block, fix the M4 Screw Rod (23) with a screwdriver and unscrew the nut a little and rotate clockwise forward Screw (24) a bit (half a circle is about 1 degree higher); and then fix the Screw Rod and fasten the nut. Do the test and display value until the value stands in the tolerance range (Table 3). If the displaying value is higher than the hardness value of the standard hardness block, rotate the Screw in the opposite direction. (There are screwdriver and spanner in accessories kit)

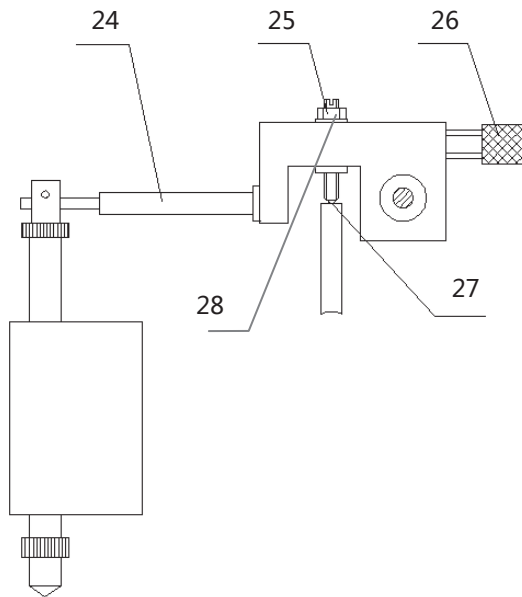

- 22. Connecting Rod
- 23. Screw Rod
- 24. Screw
- 25. Protecting Gasket
- 26. Nut

Fig 5-21

**Method2 : System Correction**

On Fig5-1, click Correction to open this function (Fig5-22), this function only can modify current scale, If result higher than nominal value, click downwards arrow modify to negative value. Otherwise, modify to positive value. Note if one indenter correct while the others not, then check indenter may be damaged.

## 5.6 Default Setup

- Default setup will delete test setup, system setup and test results, if no special case, please do not use this function. Password 88888888.
- Steps: Enter system setup, select default setup, then enter password, click Enter on lower right corner, then system starts default setup (Fig 5-23), a moment later system will back to system setup.

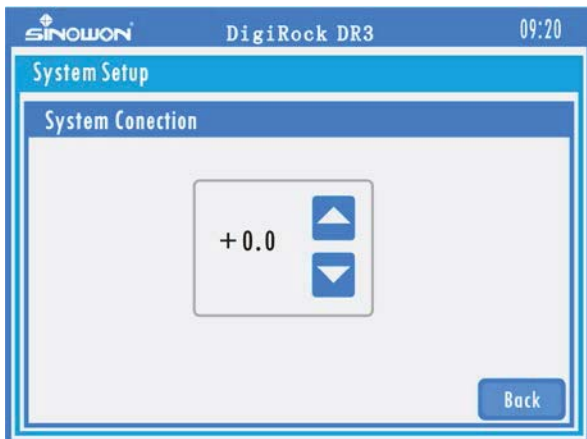

Fig 5-22 Correction Value



Fig 5-23 Ongoing Recovery

## **6 Maintenance of Hardness Tester**

### **6.1 Operation Attention**

6.1.1 The operator should observe the operation regulations and calibrate the instrument with the standard hardness block before and after the test. If the tester is rarely used, the several tests should be carried out to make the tester stable after start the instrument and then carry out the necessary tests.

6.1.2 Gently rotate lifting anvil when load initial force and unloading initial force.

6.1.3 During the hardness test, when the loading and unloading of the test force or the keep of the dwell time is being carried out, it is prohibited to turn the Load-Change Hand Wheel.

6.1.4 The standard hardness block should be used only on the working plane with the distance of the two neighboring indentations and distance of the center of the indentations to their edges are not inferior to 3 mm. The life time of the hardness blocks is 2 years.

6.1.5 Before the transportation of the tester, the Connecting Rod should be fixed, and the Weights and the Hanging Rod should be discharged. Disconnect the power source before the Weights and the Hanging Rod are taken out.

### **6.2 Daily Maintenance**

6.2.1 Keep the tester clean and cover the tester with anti-dust bag after the test, lubricate the standard hardness blocks and ball indenters with the rust protecting oil to avoid rust.

6.2.2 Carry out periodic inspection of the tester, at least once a year in order to assure the correct operation of the tester.

6.2.3 Periodically add some lubricant on lead screw and inside of force knob.

## 6.3 Trouble Shooting

6.3.1 When the test is in the un-working state, it is advisable to get in touch with the relative units for the repair. The normal and common problems should be dealt with by your self (Table 6)

Table 6

Phenomenon	Possible Causes	Method Used
When the tester is switched on, the screen is not lit up	<ol style="list-style-type: none"> <li>1 The current is blocked</li> <li>2 The fuse is broken.</li> </ol>	<ol style="list-style-type: none"> <li>1 Check the power cable.</li> <li>2 Change the fuse.</li> </ol>
When the tester is on, the keys do not work	The instrument is not in working state.	When the tester is turned on, wait for a while until the instrument returns to the working state automatically.
The Up and Down Lead Screw is blocked	The space between the Up and Down Lead Screws is too small and they are blocked by the thread ends or feculence	Remove the protecting cover of the Up and Down Lead Screw and clean the screw threads and than hold handle of Rotating Wheel with two hands up and down to pull the Up and Down Lead Screw (It is prohibited to rub the Up and Down Lead Screw with abrasive paper)
The deviation of the displaying hardness value is too great.	<ol style="list-style-type: none"> <li>1 The indenter is damaged</li> <li>2 The Weights are not installed in order.</li> <li>3 The tester is not placed in the horizontal level and the weights touch the inside wall of instrument body.</li> <li>4 The total test force or the indenter is wrongly chosen.</li> <li>5 The protecting cover of Up and Down Lead Screw is high over the supporting plane of the Testing Table</li> </ol>	<ol style="list-style-type: none"> <li>1 Change the diamond indenter or the ball indenter.</li> <li>2 Install the weights according to Fig.3</li> <li>3 Calibrate the tester with a level according to section 3.2.3</li> <li>4 Select the testing force and the indenter according to the requirements in Table 1</li> <li>5 Lower down the protecting cover of the Up and Down Lead Screw.</li> </ol>
Touch screen unable	Under testing	Unload test force, then touch screen.

## **7 After Sales Service**

- Two years warranty for main unit only for quality problem, the others accessories are not under warranty. Refer packing list of ultrasonic hardness tester.
- Please show invoice and warranty card in case need repair.
- We ask for charges for accessories not under warranty.



## 8 Storage/Transportation Attention

Storage should be far away from the vibration, corrosion, moisture, dust, also should be stored at a normal temperature and humidity. Please put in the original packing box before transportation to avoid any damage.

- **Note:** Operation manual will be updated without further notice, latest edition will be sent to customers by email timely.

**Table 1 ( Hardness Value Corrections With Testing On Convex Cylindrical Surfaces )**

Corrections to be Added to Rockwell B, F, and G Values Obtained on Convex Cylindrical Surfaces of Various Diameters

Table 1-1

Hardness Value( HR )	Diameters of Convex Cylindrical Surfaces ( mm )						
	6	10	13	16	19	22	25
	Corrections to be Added to Rockwell B, F, and G Values ( HR )						
20				4.5	4.0	3.5	3.0
30			5.0	4.5	3.5	3.0	2.5
40			4.5	4.0	3.0	2.5	2.5
50			4.0	3.5	3.0	2.5	2.0
60		5.0	3.5	3.0	2.5	2.0	2.0
70		4.0	3.0	2.5	2.0	2.0	1.5
80	5.0	3.5	2.5	2.0	1.5	1.5	1.5
90	4.0	3.0	2.0	1.5	1.5	1.5	1.0
100	3.5	2.5	1.5	1.5	1.0	1.0	0.5

Corrections to be Added to Rockwell A, C, and D Values Obtained on Convex Cylindrical Surfaces of Various Diameters

Table 1-2

Hardness Value ( HR )	Diameters of Convex Cylindrical Surfaces ( mm )								
	6	10	13	16	19	22	25	32	38
	Corrections to be Added to Rockwell A, C, and D Values ( HR )								
20				2.5	2.0	1.5	1.5	1.0	1.0
25			3.0	2.5	2.0	1.5	1.0	1.0	1.0
30			2.5	2.0	1.5	1.5	1.0	1.0	0.5
35		3.0	2.0	1.5	1.5	1.0	1.0	0.5	0.5
40		2.5	2.0	1.5	1.0	1.0	1.0	0.5	0.5
45	3.0	2.0	1.5	1.0	1.0	1.0	0.5	0.5	0.5
50	2.5	2.0	1.5	1.0	1.0	0.5	0.5	0.5	0.5
55	2.0	1.5	1.0	1.0	0.5	0.5	0.5	0.5	0
60	1.5	1.0	1.0	0.5	0.5	0.5	0.5	0	0
65	1.5	1.0	1.0	0.5	0.5	0.5	0.5	0	0
70	1.0	1.0	0.5	0.5	0.5	0.5	0.5	0	0
75	1.0	0.5	0.5	0.5	0.5	0.5	0	0	0
80	0.5	0.5	0.5	0.5	0.5	0	0	0	0
85	0.5	0.5	0.5	0	0	0	0	0	0
90	0.5	0	0	0	0	0	0	0	0

**Table 2 (Allowable Repeatability and Error Table)**

Rockwell Scales	Hardness Range	Max Error
HRA	(20 ~ 75)HRA	±2HRA
	(> 75 ~ 88)HRA	±1.5HRA
HRB	(20 ~ 45)HRB	±4HRB
	(> 45 ~ 80)HRB	±3HRB
	(> 80 ~ 100)HRB	±2HRB
HRC	(20 ~ 70)HRC	±1.5HRC
HRD	(40 ~ 70)HRD	±2HRD
	(> 70 ~ 77)HRD	±1.5HRD
	(> 90 ~ 100)HRE	±2HRE
HRF	(60 ~ 90)HRF	±3HRF
	(> 90 ~ 100)HRF	±2HRF
HRG	(30 ~ 50)HRG	±6HRG
	(> 50 ~ 75)HRG	±4.5HRG
	(> 75 ~ 94)HRG	±3HRG
HRH	(80 ~ 100)HRH	±2HRH
HRK	(40 ~ 60)HRK	±4HRK
	(> 60 ~ 80)HRK	±3HRK
	(> 80 ~ 100)HRK	±2HRK
HRE	(70 ~ 90)HRE	±2.5HRE
HRL	(100 ~ 120)HRL	±1.2HRL
HRM	(85 ~ 110)HRM	±1.5HRM
HRR	(114 ~ 125)HRR	±1.2HRR



ISO 9001:2015 Certified Company



**Sinowon Innovation Metrology Manufacture Limited**

Address:A1 ,KaiSong Park,2 # Baima Xianfeng  
Road,South District,DongGuan,China (523080)

Tel:0086-769-23184144 Fax:0086-769-22854144

Web:www.sinowon.com E-mail:sinowon@188.com

**Hotline:0086-137-2828-8444**

Authorized Distributors:

